

# TÖYÖTÖMI

## Kerosene-Fired and Oil-Fired Water Heater Operation and Maintenance Instructions

### MODEL **BS-36UFF** (Type C)



#### IMPORTANT

READ AND UNDERSTAND INSTRUCTIONS BEFORE INSTALLING OR USING THIS WATER HEATER. RETAIN INSTRUCTIONS FOR FUTURE REFERENCE. CHECK LOCAL CODES AND ORDINANCES FOR PERMITTED USE.

#### CAUTION

THIS WATER HEATER SHALL NOT BE USED FOR COMMERCIAL USE OR FOR ANY PURPOSES OTHER THAN HOT WATER SUPPLY USES. OTHER USAGE MAY CAUSE A MALFUNCTION OR SHORTEN ITS SERVICE LIFE. DO NOT REMOVE THE RATING PLATE AND LABELS FROM THE WATER HEATER UNIT.

### CONTENTS

SECTION A:	Inspection Before Operation .....	8
Safety Tips .....	Operation .....	9
Safety Features .....	Adjusting Water Temperature .....	9
	Flow Rate and Water Temperature .....	10
SECTION B:	Turning Unit Off .....	10
Specifications .....	Preventing Freeze Up .....	10
Dimensional Outline .....	Long Term Inactivity .....	11
Control Panel .....	SECTION E:	
Construction .....	Routine Maintenance	
SECTION C:	Inspection and Maintenance .....	12
Fuel Guide .....	Inspection and Maintenance Items .....	12
SECTION D:	SECTION F:	
Operation	Troubleshooting .....	13
Fueling .....		
8		

# SECTION A: SAFETY TIPS

---

## BE SURE TO FOLLOW THE FOLLOWING INSTRUCTIONS.

The instructions which are contained in this manual are classified into the following two types, which are "WARNING" and "CAUTION". These instructions are intended to provide important information for safe operation.

**"WARNING"** indicates the possibility of causing the user a fatal accident or serious injury if the water heater is incorrectly operated.

**"CAUTION"** indicates the possibility of causing the user injuries or material damages if the water heater is incorrectly operated.

### **WARNING**

1. Never use any fuel other than water-clear kerosene (ASTM No. 1-K grade) or No.1 fuel oil. NEVER USE GASOLINE! Use of such fuels can result in an explosion and/or fire and cause injury.
2. Never store flammable liquids or materials such as gasoline near the unit.
3. This unit should be installed by a licensed, authorized person(s) due to the necessity of making electrical, water and fuel connections.
4. RISK OF BACKFIRE AND INDOOR AIR POLLUTION. Before operation make sure flue pipe is free of snow, icing, leaves, bird's nest or strong drafts.
5. RISK OF INDOOR AIR POLLUTION AND FIRE. Be sure the exhaust pipe is properly installed and connected. Aluminum tape may be used for sealing exhaust pipe connections.
6. RISK OF INJURY FROM MOVING PARTS AND ELECTRICAL SHOCK. Disconnect power cord before servicing unit.
7. This water heater is designed to be used no more than 6,890 FT. (2,100 m) above sea level. The water heater may have a failure of combustion at a high altitude.  
Ask your local dealer for using at altitudes higher than 4,922 FT. (1,500 m) ~ 6,890 FT. (2,100 m) above sea level.  
If the water heater is installed at an altitude of higher than 2,953 FT. (900 m) above sea level, the exhaust pipe or the air inlet hose shall not be elongated or connected with its extension pipe. The standard installation only is allowed for installing the water heater at such altitude.

### **CAUTION**

1. HOTTER WATER INCREASES THE RISK OF SCALD INJURY. Water heaters are intended to produce hot water. Water heated to a temperature which will satisfy clothes washing, dish washing, and other sanitizing needs can scald and permanently injure you upon contact. Before changing temperature setting make sure nobody is using a shower. High temperature setting increases the risk of scald injury. Temperature has been set at factory to about 130°F.
2. RISK OF SCALD INJURY. When using a shower, feel the temperature of the water with your hand before getting under the water.
3. RISK OF SCALD INJURY. Do not touch hot water flowing from temperature and pressure relief valve.
4. RISK OF BURN INJURY. Do not touch flue pipe top and exhaust pipe. The insulated material provided should be installed around the exhaust pipe. Due to high surface temperature, keep children away from the unit.

## **OTHER PRECAUTIONS**

1. This unit is only for indoor use. Avoid its exposure to rain or moisture.
2. Do not use for drinking or cooking until the water supply has been approved by local authorities.
3. Hot water (or cold water) left in heat exchanger or piping must not be used for cooking or drinking.
4. When using a large amount of hot water the temperature may change, even though the temperature setting has not been changed. Special caution must be taken if two faucets are open at the same time.
5. If the unit appears to be operating abnormally or in an emergency, turn off the unit and call an authorized service person.
6. Avoid the use of hard water. In regions where hard water is the only source, take advantage of a water softener.
7. Do not use a damaged unit. If repairs are needed, contact your dealer.
8. Keep the area around the unit, the fuel tank and the flue pipe clean and free of flammable materials.
9. If you plan to be away from your home for a long period of time, shut-off the fuel valve on the fuel tank. Press "POWER SWITCH" to "OFF" position and disconnect the power supply cord.
10. If the unit is not used for a long period of time, the fuel tank may contain water cause by condensation. Be sure to check all filters and strainers for this condition, clean or replace filter elements before using the unit.
11. The use of the water heater with the temperature selector knob at "B", "HOT", or "COLD" may propagate bacteria growth in the water. In order avoid this, turn the temperature selector knob to "VERY HOT" once a week to heat the water heater and water to a high temperature for approximately one hour.
12. Before changing the temperature setting, make sure that the water heater is not being used by any of your family at any place in the house. All family members should be aware of this "Caution."
13. Fusible Link Valve (#10005597)
  - It is most important that the valve, depending on its use, be fully opened or fully closed.
  - The top nut on the valve (below the turn handle) is sealed and should never be tightened or removed.
  - When installing fuel lines to the valve, be sure to check for fuel leakage.
  - A LEAKING VALVE SHOULD ALWAYS BE REPLACED.

## **SAFETY FEATURES**

**1. Ignition Safety Device (Flame Sensor)**

The unit will automatically stop all operations if ignition fails or if the flame fails during combustion. "WARNING" lamp will light.

**2. Over Heat Protector**

In order to prevent burns, the over heat protector automatically stops all operations if the water in the heat exchanger reaches abnormally high temperatures due to temperature controller malfunction. The "WARNING" lamp will light.

**3. Power Failure Recovery System**

If power fails during water heater operation the unit will turn off. When power resumes the unit will automatically reignite.

**4. Fully Vented System**

Flue pipe system provides outside air for combustion and vents all combustion products to the outdoors.

**5. Fusible Link Valve**

If a household fire should occur, causing the fuel line or water heater to become extremely hot, the fusible link valve will stop the fuel supply to the burner. This will prevent the fuel supply from the external tank from continuing to flow into the house.

**6. Fuel Strainer**

Special strainer catches any dirt or impurities present in the fuel before it is sent to the burner.

**7. Heat Exchanger Bi-Metal Switch**

If the heat exchanger temperature becomes abnormally hot because of a malfunctioning thermostat, the burner is automatically extinguished and the "WARNING" lamp will light.

**8. Temperature Fuse**

When the air around the heat exchanger rises to an abnormal level, the temperature fuse will blow and the unit will turn off. The "WARNING" lamp will light.

**9. Air Pressure Switch**

When the air flow volume reduces or the flue pipe is clogged, the burner is automatically extinguished and the "WARNING" lamp will light up.

# SECTION B: SPECIFICATIONS

---

## SPECIFICATIONS

Model:	BS-36UFF (Type C)	
Type:	Combustion Type Flue Pipe Heating Supply System Source of Water	Pressure Vapor Forced Flue Instantaneous Direct Connection to Main Supply
Ignition:	High Voltage Discharge Spark	
Fuel:	ASTM No.1-K Grade Kerosene or No.1 Fuel Oil	
Efficiency:	88% <sup>(1)</sup>	
Hot Water Input:	148,000 BTU/h	
Fuel Consumption:	1.1 gal/h	
Capacity of Heat Exchanger:	5.10 gal	
Fuel system:	External tank <sup>(2)</sup>	
Dimensions (W x H x D):	12-5/8" x 27-3/4" x 22-1/2"	
Weight:	86 lbs. Empty	
Vent Pipe Hole:	4-3/4 diameter	
Maximum Length of Vent Pipe System:	10 ft., 3 bends or less	
Electrical Rating:	120 Volts AC, 60 Hz Ignition - 120W Burning - 98W	
Required Accessories:	Fuel strainer, Temp & pressure relief valve	
Safety Device:	Over-heat protector, Ignition safety device, Heat exchanger bi-metal switch, Temperature fuse, Fusible link valve	
Exhaust Air Temperature:	less than 500°F	
Nozzle:	Quantity of Vapor Spraying Angle Spray Pattern	1.1 GPH 60° Delavan Type A
Temperature Fuse:	282°F	
Electric Current Fuse:	5 A	

(1) Heat and vaporized water are produced by the combustion process of this water heater. This rating does not take into account heat loss due to condensation of water vapor.

(2) External tank to be purchased from local suppliers.

# DIMENSIONAL OUTLINE

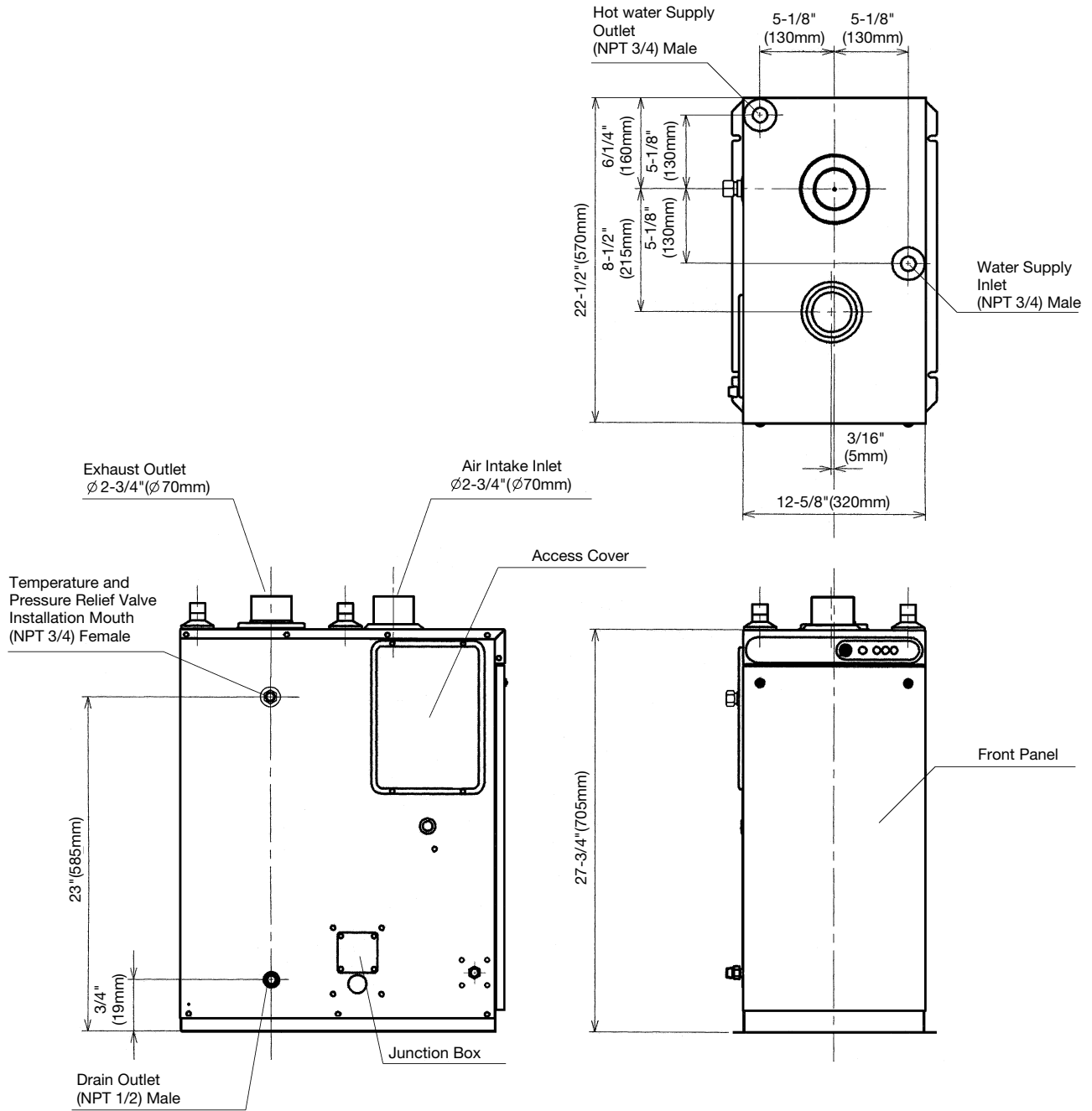

# CONTROL PANEL

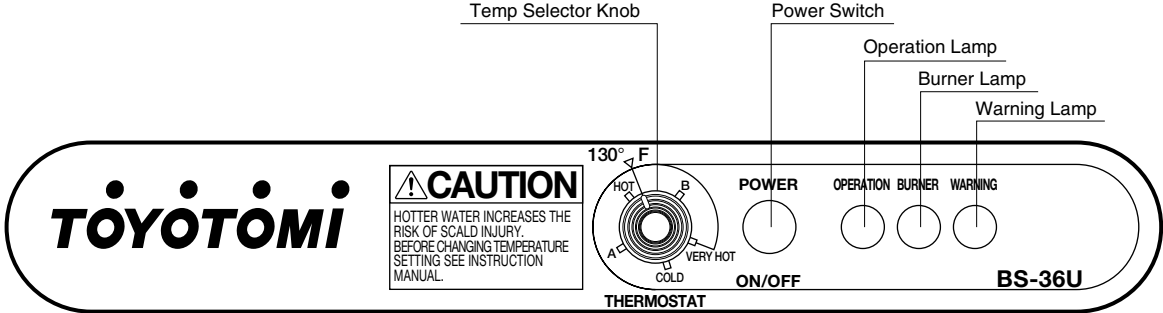

# CONSTRUCTION

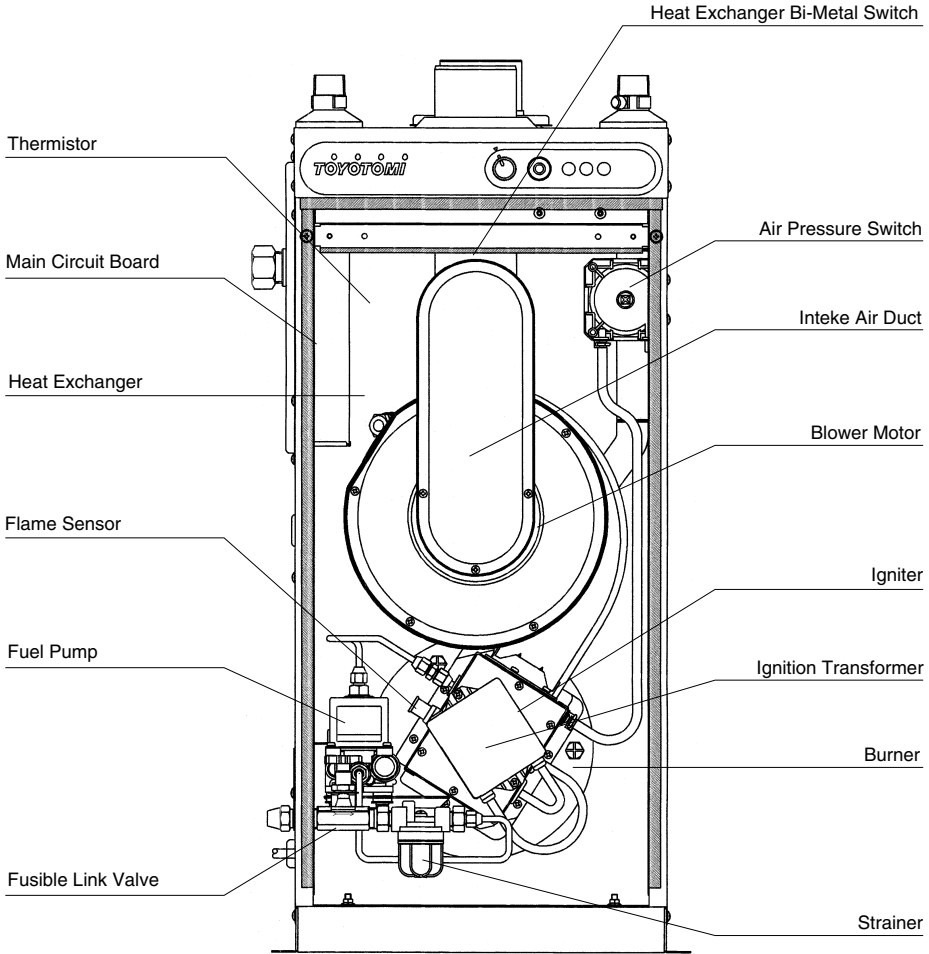

## SECTION C: FUEL GUIDE

---

The Toyotomi BS-36UFF is designed for use with ASTM No. 1-K Grade kerosene or No.1 fuel oil only. Use of low-quality kerosene will cause burner performance to drop, leading to abnormal combustion and reduced the unit life.

Purchase only 1-K kerosene or No.1 fuel oil in non-red cans reserved exclusively for fuel and marked accordingly with the word "KEROSENE" or "No.1 FUEL OIL". Always store your fuel in a separate area from where you store gasoline for your power equipment to avoid accidental use of gasoline in your water heater.

### What to Buy...

- ALWAYS: Clean and high-quality KEROSENE, ASTM No. 1-K or No.1 fuel oil.
- ALWAYS: Fuel free of contaminants, water or cloudiness.
- NEVER: Gasoline, alcohol, white gas, camp stove fuel or additives.
- NEVER: Yellow or sour-smelling fuel.

### How to Store It...

- ALWAYS: Store in a clean container, non-red in color, clearly marked "KEROSENE" or "No.1 FUEL OIL".
- ALWAYS: Store away from direct sunlight, heat sources or extreme temperature changes.
- NEVER: In a glass container, or one that has been used for other fuels.
- NEVER: For longer than six months.
- NEVER: In the living space.

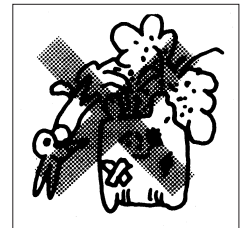
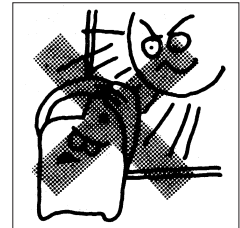

### Why It is Important...

Pure, clean kerosene is essential for safe and efficient water heater operation. Poor quality or contaminated fuel can cause:

- Excess tar deposits on burner and flue pipe
- Incomplete combustion
- Reduced unit life

Use of a highly volatile flammable fuel such as gasoline can produce uncontrollable flames, creating a severe fire hazard.



## SECTION D: OPERATION

---

### FUELING

**WARNING:** Use KEROSENE (ASTM No. 1-K) or No.1 fuel oil only. Never use gasoline, thinner, benzene, light oil or waste oil.

**CAUTION:** Make sure that the fuel is clean and free from dirt and water. Water and dirt may cause combustion failure and shorten the life of components such as the fuel pump. Be sure to refuel before the tank runs out. Avoid having the fuel tank and fuel line run empty.

#### REMOVING AIR TRAP

When operating for the first time or when refueling an empty tank, air may be trapped in the fuel line, making ignition difficult. In this situation, follow the procedures below:

1. Press "POWER SWITCH" to "OFF" position. Disconnect the power supply cord.
2. Release the two (2) screws from the front panel and remove the front panel.
3. To catch the fuel which will drain out, put a small container under the strainer.
4. Loosen the screw on top of the strainer. Immediately wipe off any spilled fuel.
5. Remove the trapped air thoroughly. Failure to remove all the air will cause improper ignition and may extinguish the unit.
6. Tighten the screw after removing trapped air.
7. Reconnect the power supply cord. Press "POWER SWITCH" to "ON" position.  
Note: In the event of an ignition failure, press "POWER SWITCH" to "OFF" position and after 10 seconds press "POWER SWITCH" to "ON" position once again.

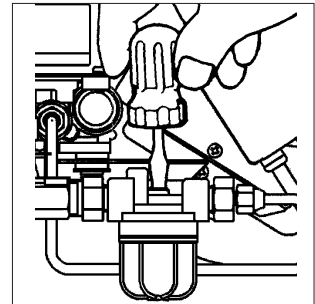

### INSPECTION BEFORE OPERATION

1. Before turning on the POWER SWITCH, make sure that the water supply inlet is open and that water runs out properly by opening a hot water faucet. If not, check the drain valve to see if it has been left open.
2. Check for water leaks in the pipes.
3. Be sure there is a sufficient amount of fuel in the tank and that there are no leaks in the pipe line.
4. Be sure the power supply is properly connected and grounded to the unit.
5. Be sure the area around the water heater is clear of flammable materials such as gasoline, thinner or flammable vapors.
6. Be sure the exhaust and flue pipes are securely connected and that there are no leaks.

## OPERATION

- CAUTION:
- Hotter water or high temperature setting increases the risk of scald injury.
  - Thermostat has been set at factory to about 130°F.
  - Risk of scald injury. When using a shower, feel the temperature of the water with your hand before getting under the water.
  - When using a large amount of hot water the temperature may change, even though the temperature setting has not been changed. Special caution must be taken if two faucets are open at the same time.

1. Open the fuel tank valve.
2. Press "POWER SWITCH" to "ON". "OPERATION" lamp will come on. Automatic operation is based upon the temperature of water inside the heat exchanger. "BURNER" lamp is lit when the burner is in its operation mode.

NOTE: When operating for the first time or after running out of fuel, ignition may not occur because of air in the fuel line. In that case, remove air as described in the previous section.

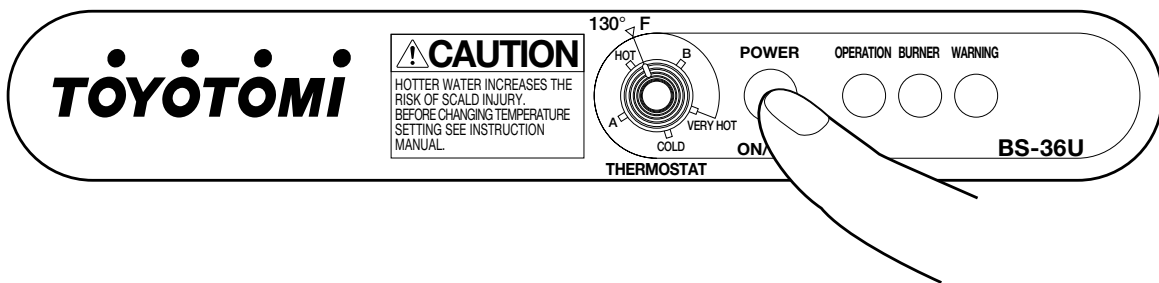

## ADJUSTING WATER TEMPERATURE

- CAUTION:
- Hotter water or high temperature setting increases the risk of scald injury.
  - Thermostat has been set at factory to about 130°F.
  - Risk of scald injury. When using a shower, feel the temperature of the water with your hand before getting under the water.
  - Risk of scald injury. Before changing the temperature setting, make sure that the water heater is not being used by any of your family at any place in the house.
  - When using a large amount of hot water the temperature may change, even though the temperature setting has not been changed. Special caution must be taken if two faucets are open at the same time.
  - The use of the water heater with the temperature selector knob at "B", "HOT", or "COLD" may propagate bacteria growth in the water. In order avoid this, turn the temperature selector knob to "VERY HOT" once a week to heat the water heater and water at high temperature for approximately one hour.

To increase the hot water temperature, turn the temperature selector knob clockwise. To decrease the hot water temperature, turn the temperature selector knob counterclockwise.

Position of Temperature Selector Knob	Hot Water Temperature
VERY HOT	around 155°F
B	around 147°F
HOT	around 112°F
A	around 88°F
COLD	around 69°F

- NOTE:
- Seasonal change of water temperature from the main water source results in different hot water temperature supplied. Use hot water supply faucet to control hot water temperature, or readjust temperature setting.
  - The hot-cold mixing faucet is recommended to ensure safe and comfortable use of the water heater. Choose a mixing faucet which can provide a comfortable water temperature with less temperature fluctuation.
  - After installing the mixing faucet, set the temperature selector knob at the position of "VERY HOT" and then gradually adjust the water temperature by adding cold water to your preferable level. Sufficient care must be taken not to misoperate this adjustment, which may result in scalding your hands.

### FLOW RATE AND WATER TEMPERATURE

SEASON	INCOMING WATER TEMP	HOT WATER TEMP	FLOW RATE
SUMMER	80°F	120°F (40°F RISE)	6.1 GPM
SPRING & FALL	60°F	120°F (60°F RISE)	4.0 GPM
WINTER	40°F	120°F (80°F RISE)	3.0 GPM

NOTE: Whenever high temperature water is required for continuous demand, lessen the flow rate. Whenever low temperature water is required, the flow rate may be increased. The flow rates are calculated under the conditions of standard installation and normal usage so that they will vary according to installation, usage and temperature.

### TURNING UNIT OFF

1. Press "POWER SWITCH" to "OFF" position. All lamps will go out.

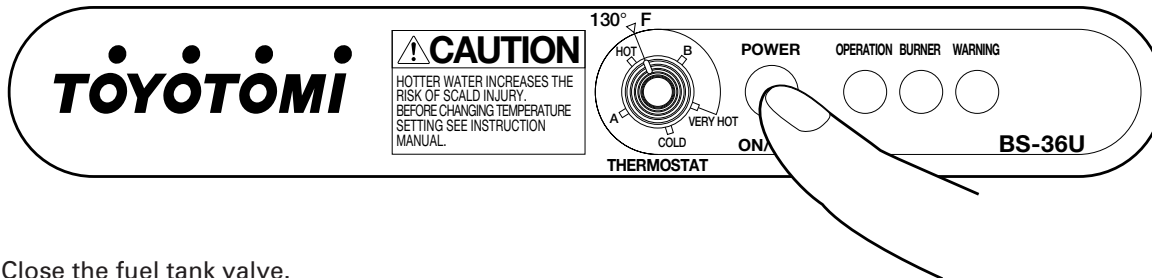

2. Close the fuel tank valve.

### PREVENTING FREEZE UP

In order to prevent any kind of damage or leaks caused by freezing, keep the pipes heated at all times, as specified below.

**CAUTION:** In order to prevent the water heater from being broken or develop a leak, regardless of being used in a cold region or in a warm or hot region, the water supply piping, hot water supply piping, drain pipe, check valve, valves, expansion tank, and temperature & pressure relief valve are to be protected with sufficient insulation materials (by wrapping with heat insulation or by equipping an freeze prevention heater).

1. OPERATING AT HIGH TEMPERATURE

**CAUTION:** Risk of scald injury. Before changing temperature setting make sure that the water heater is not being used by any of your family at any place in the house.

Set the Thermostat to the "VERY HOT" position, and press "POWER SWITCH" to "ON" position.

**NOTE:** Since this method cannot prevent the water inside of the piping from being frozen, sufficient insulation measures are to be given according to the requirements mentioned in the above cautions.

## 2. DRAINING WATER

When you do not plan to use the unit for an extended period, the following procedures are recommended.

1. Turn the unit off.
2. Disconnect the power supply cord.
3. Close the fuel tank valve securely.
4. After closing the main water supply valve, open up all the faucets.
5. Open the drain valve on the bottom of the unit.
6. Pull up the lever of the temperature and pressure relief valve.

**NOTE:** If the water heater is not used in the winter season or in a cold region where the water supply is frozen, or if it is not used for a long period of time, the water heater should be drained and related piping system shut off completely.

When re-supplying water in the water heater and system:

1. Close the air exit valve, if it is provided for the piping.
2. Close the drain valve.
3. Pull down the lever of the temperature and pressure relief valve.
4. Close all the hot and cold mixing faucets once.
5. Fully open the main water supply valve.
6. First slowly open the valve for the hot and cold mixing faucet which is located in the farthest position and gradually increase the flow rate as water starts flowing continuously.

**NOTE:** Since the water heater and piping system still have much air left after they are drained, a flash flow of water may be caused by such air pressure when re-supplying water through them. First open the valve carefully and gradually increase its opening to "Full Open" when the water flow becomes stable. When air bubbles disappear in the water, fully open the valve for hot and cold mixing faucet.

7. Also flow water through other hot and cold mixing faucets by the procedure of item 6 above.
8. Fully open the feed fuel valve for the fuel tank.
9. Connect the power supply cord.
10. Press the "POWER SWITCH" to "ON" position.
11. Next open the valve for hot and cold mixing faucet, so hot water will flow out.

### **Operation start of the water heater in a cold region:**

Before starting the water heater, open a valve for a hot and cold mixing faucet to make sure that water flows out. Neither water flow nor smooth water flow occurs when the water heater and piping system are frozen. If this happens, wait until such frozen water is melted and re-start the operation of the water heater when water flows properly.

## **LONG TERM INACTIVITY**

When leaving the unit unused over a long period of time, drain the heat exchanger and pipes thoroughly and disconnect the electrical cord.

# SECTION E: ROUTINE MAINTENANCE

---

## INSPECTION AND MAINTENANCE

**WARNING:** RISK OF INJURY FROM MOVING PARTS AND ELECTRICAL SHOCK. Disconnect the power supply cord before inspecting and servicing unit. All repairs should be left to professionals. RISK OF BACKFIRE AND INDOOR POLLUTION. Before operation make sure the flue pipe is free of snow, icing, leaves, bird's nest or strong drafts.

**CAUTION:** RISK OF BURN INJURY. Do not touch the flue pipe top and the exhaust pipe.

When inspecting, ALWAYS do the following.

- a. Press the Power Switch to OFF position.
- b. Disconnect the power plug from the receptacle.
- c. Close the fuel feed valve.

When inspecting, NEVER do the following.

- a. Do not remove the thermistor.
- b. Do not adjust the pressure of the fuel pump.

## INSPECTION AND MAINTENANCE ITEMS

1. **FLAMMABLE IN THE ENVIRONMENT (REGULARLY)**  
Remove all flammable material from the area.
2. **FUEL LEAKS (REGULARLY)**  
Always check for oil leaks. Clean off spilled fuel thoroughly when lubricating fuel. If a leak is found, shut down the unit until the problem is corrected.
3. **FUEL FEED LINE INSPECTION (REGULARLY)**  
Check for fuel leaks from the fuel feed line. Replace it if any cracks or leaks are found.
4. **WATER LEAKS (REGULARLY)**  
Check the heat exchanger for water leaks. Always correct if found.
5. **ODOR OR SOOT (REGULARLY)**  
If you notice soot at exhaust pipe fittings, exhaust gas may be leaking from the pipe joints. Consult your dealer.
6. **DUST (ONCE A MONTH)**  
Check for dust inside of the unit and the bottom (base).
7. **WATER INSIDE THE FUEL TANK (ONCE A MONTH)**  
Remove any water or waste particles that accumulate inside the fuel tank.
8. **FUEL STRAINER (ONCE A MONTH)**  
Vibration, noise, ignition and combustion failure could be caused by water or waste particles in the fuel strainer. Clean the strainer once a month.
9. **FLUE PIPE (ONCE A MONTH)**  
A clogged flue pipe will cause improper combustion. Inspection for any clogging or soot accumulation should be done at least once every year. Make sure not to place combustibles in the flue pipe area.

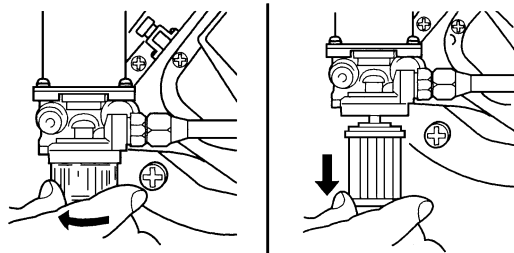

10. TEMPERATURE AND PRESSURE RELIEF VALVE (ONCE A MONTH)  
The temperature and pressure relief valve may become immovable at times due to corrosion of pipes or mineral deposits in the pipes. Pull up the lever of the temperature and pressure relief valve every month and make sure the valve is movable.
11. PLUG AND RECEPTACLE (ONCE A MONTH)  
Make sure the plug is free of dust. Be sure plug fits receptacle securely.
12. BURNER INSPECTION (ONCE SIX MONTH)  
Check the burner and combustion area for soot. Clean if found.
13. GASKETS AND WASHERS (ONCE SIX MONTH)  
Check for water leaks caused by improper sealing of the water pipe. If there are leaks, gaskets or sealant must be replaced.
14. FLAME SENSOR (PHOTOELECTRIC CELL) (ONCE SIX MONTH)
  - a. Take out the flame sensor which is located to the left of the burner inside the cabinet.
  - b. If the beam receiving surface of the flame sensor becomes dirty or contaminated, the unit will not operate properly. The beam receiving surface should be wiped with a soft cloth every 6 months.
15. BLOWER MOTOR (ONCE SIX MONTH)  
Make sure there is no dust on the blower motor fan.
16. HEAT EXCHANGER (ONCE A YEAR)  
Open the drain valve at least once a year to drain the heat exchanger. Pull up the lever of the temperature and pressure relief valve to allow air to enter the heat exchanger.

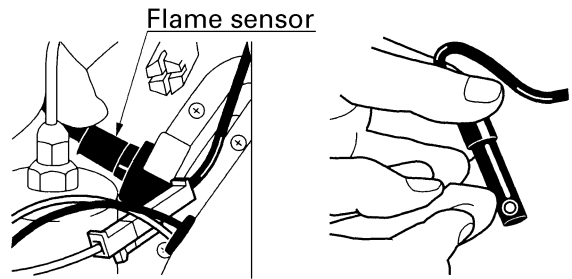

## SECTION F: TROUBLESHOOTING

---

**WARNING:** RISK OF INJURY FROM MOVING PARTS AND ELECTRIC SHOCK.

Disconnect the power supply cord before servicing unit. All repairs should be left to professionals.

**WARNING:** Do not re-use the unit until the cause of the problems have been determined.

**CAUTION:** RISK OF BURN INJURY. Do not touch the unit and the heat exchanger while in hot.

If there is any abnormality, determine for the causes from the list below and perform the specified measure. Consult your dealer if problems cannot be corrected from this chart.

	PROBLEM	CAUSE	SOLUTION
	POWER LAMP FAILS TO TURN ON	Disconnected power supply cord	Connect power supply cord.
	ALARM LAMP LIGHTS AFTER TURNING ON.	Thermistor malfunction Out of water in heat exchanger Flame sensor malfunction Light is received on the receiving surface of photoelectric cell Bi-metal switch activated	Consult your dealer. Supply water. Consult your dealer. Consult your dealer.  Consult your dealer.
	BLOWER MOTOR OPERATES BUT IGNITION FAILS.	Abnormal location and adjustment of electrode Igniter malfunction. Abnormal lowering of electrical voltage Out of fuel  Air pocket in fuel pipe. Clogged fuel strainer Circuit board malfunction Temperature fuse activated. Air pressure switch activated or malfunction	Consult your dealer.  Consult your dealer. Contact electricians.  Check fuel gauge on fuel tank; refuel. Remove air pocket. Clean strainer. Consult your dealer. Consult your dealer. Check air intake line. Replace it. Replace it.
	EXTINGUISHED AFTER IGNITION	Stained light-intercepting surface of flame sensor Flame sensor malfunction Air pocket in fuel pipe	Consult your dealer.  Replace it. Remove air pocket completely.
	NOISE FROM FUEL PUMP	Air lock in fuel line Clogged intake line and pump	Remove air. Consult your dealer.
	NOISY COMBUSTION	Fuel flow too much Fuel flow too little Fuel nozzle malfunction Improper installation of flue pipe	Consult your dealer. Consult your dealer. Replace it. Re-install properly.
	HOT WATER TEMP TOO LOW	Thermistor malfunction Hot water supply beyond capacity	Consult your dealer. Close hot water faucet partially.
	SOOT ACCUMULATION	Dusty blower motor fan Improper installation of flue pipe Fuel flow too much Fuel nozzle malfunction	Consult your dealer. Re-install properly. Consult your dealer. Replace it.
	FUEL LEAKAGE FROM FUEL PIPE	Loose connection of fuel pipes	Consult your dealer.
	WATER LEAKAGE	Water leakage from heat exchanger (Heat exchanger malfunction) Gasket malfunction	Consult your dealer.  Replace it.

# LIMITED WARRANTY

TOYOTOMI U.S.A., INC. ("TOYOTOMI") warrants each product and any parts thereof sold by it to be free from defects in materials or workmanship under normal use and service for TWELVE (12) MONTHS\* from the date of delivery to the original purchaser at retail subject to the following terms and conditions :

**WHAT IS COVERED :** Product or any parts thereof which are defective in materials of workmanship.

**WHAT IS NOT COVERED :**

(1) This warranty does not extend to any defect due to the negligence of others: failure to install, operate, or maintain unit in accordance with instructions (Installation and Operation instructions are furnished with each new unit); unreasonable use; accidents; alteration, use of unauthorized or non-standardized TOYOTOMI parts and accessories; electrical malfunction, i.e., as resulting from large power surges, short circuit, etc.; incorrect installation; use of any fuel other than that specified in owner's manuals; or repair by anyone other than a service facility specified by TOYOTOMI.

(2) Normal wear and tear of parts, including hoses, wires, burner mats, fuel nozzles, filters and accessories.

(3) This warranty does not cover shipping costs.

**WHO IS COVERED :** The original purchaser at retail.

**WHAT WE WILL DO :** TOYOTOMI will either repair or replace, at its option, all defective parts free of charge that are covered by this limited warranty on a carry-in basis, to your nearest authorized dealer or distributor of TOYOTOMI.

**WHAT YOU MUST DO FOR WARRANTY SERVICE :** You must return the defective Product or part to any authorized dealer or distributor of TOYOTOMI with this LIMITED WARRANTY and a copy of your bill of sale or credit card charge receipt or other documents evidencing the date of the Product's delivery, if service is not available locally, please contact our CUSTOMER RELATIONS DEPARTMENT at :

TOYOTOMI U.S.A., INC.  
604 Federal Road, Brookfield, CT 06804  
(203)775-1909

THE FOREGOING EXPRESSES ALL OF TOYOTOMI'S OBLIGATIONS AND LIABILITIES WITH RESPECT TO THE QUALITY OF PRODUCT FURNISHED BY IT. ALL OTHER WARRANTIES, EXPRESSED OR IMPLIED, INCLUDING THE WARRANTIES OF MERCHANTABILITY OR FITNESS FOR A PARTICULAR PURPOSE ARE DISCLAIMED. TOYOTOMI SHALL NOT BE LIABLE FOR THE LOSS OF USE OF THE PRODUCT, INCONVENIENCE, LOSS OR ANY OTHER DAMAGES, DIRECT OR CONSEQUENTIAL ARISING OUT OF, THE USE OF, OR INABILITY TO USE, THE PRODUCT OR DAMAGES RESULTING FROM OR ATTRIBUTABLE TO DEFECTS IN THE PRODUCT.

No one other than TOYOTOMI has authority to extend or modify the terms of this Limited Warranty in any manner whatsoever.

Some states or provinces do not allow the exclusion or limitation of incidental or consequential damages or limitations on how long an implied warranty lasts, so these limitations or exclusions may not apply to you. This Limited Warranty gives you specific legal rights and you may also have other rights that vary from state to state, or province to province.

\* In addition to the warranty period stated above, an extended two (2) year warranty (3 years from date of purchase) is on for the following parts. :

1. Vented Heater :
  - A. Burner Pot
  - B. Heat Chamber (Excluding Glass Cylinder)
  - C. Heat Exchanger
2. Hot Water Heater :
  - A. Burner Top
  - B. Heat Exchanger

**NOTE :** THE EXTENDED WARRANTY POLICY IS APPLICABLE ONLY FOR THE REPLACEMENT OF THE ORIGINAL FACTORY-INSTALLED PARTS THAT HAVE FAILED WITHIN THE TIME LIMITATIONS AS INDICATED. REPLACEMENT PARTS ARE WARRANTED FOR THE REMAINDER OF THE ORIGINAL PART WARRANTY PERIOD. LABOR IS NOT COVERED ON THE EXTENDED WARRANTY.

4685003051

## TOYOTOMI U.S.A., INC.

604 Federal Road, Brookfield, CT 06804

www.toyotomiusa.com

***This manual supersedes earlier editions. PART No.20476432***