

TOYOTOMI

WATER HEATER ACCESSORIES

USE ONLY TOYOTOMI GENUINE PARTS AND ACCESSORIES
ALL PARTS AND ACCESSORIES ARE UL/CSA/ETL LISTED.

STANDARD INSTALLATION PARTS

Flue Pipe Installation Kit #20476440

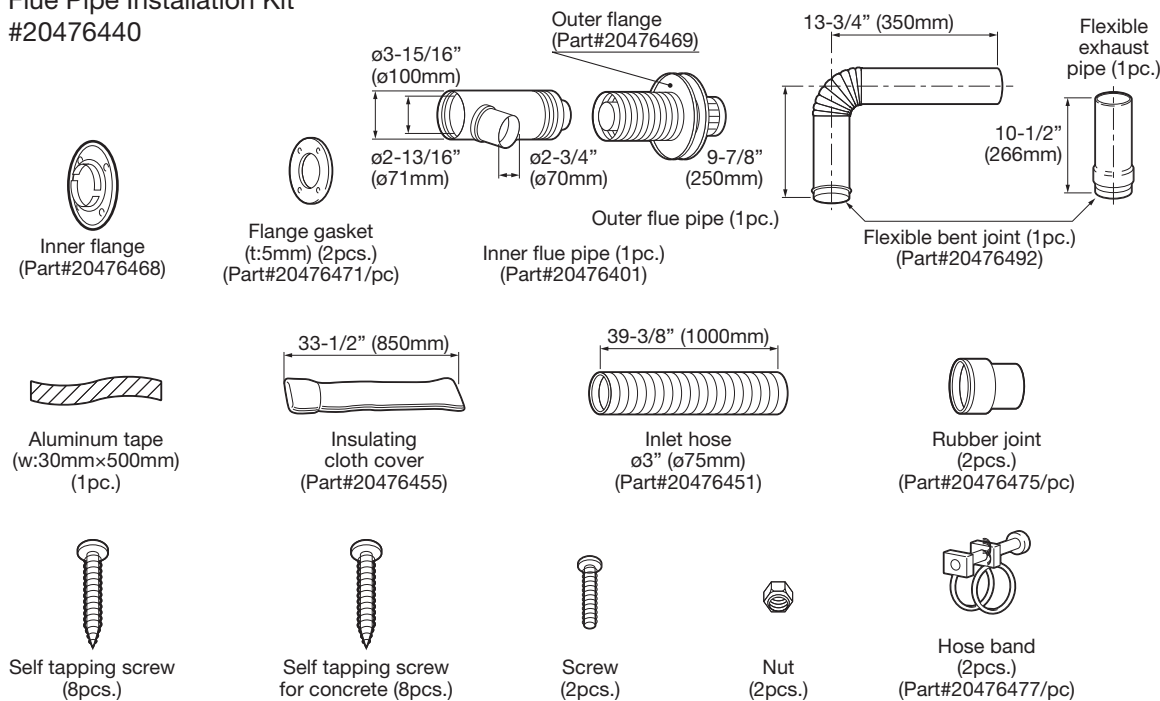

Chimney Installation Adapter Kit #20476430 - Dia. 5" #20476415 - Dia. 4"

EXHAUST PIPE ADAPTER

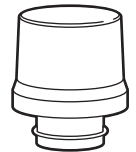

INTAKE PIPE TOP

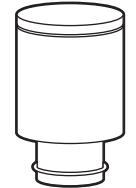

ACCESSORY PARTS (OPTION)

Extension Pipe Kit #20476496

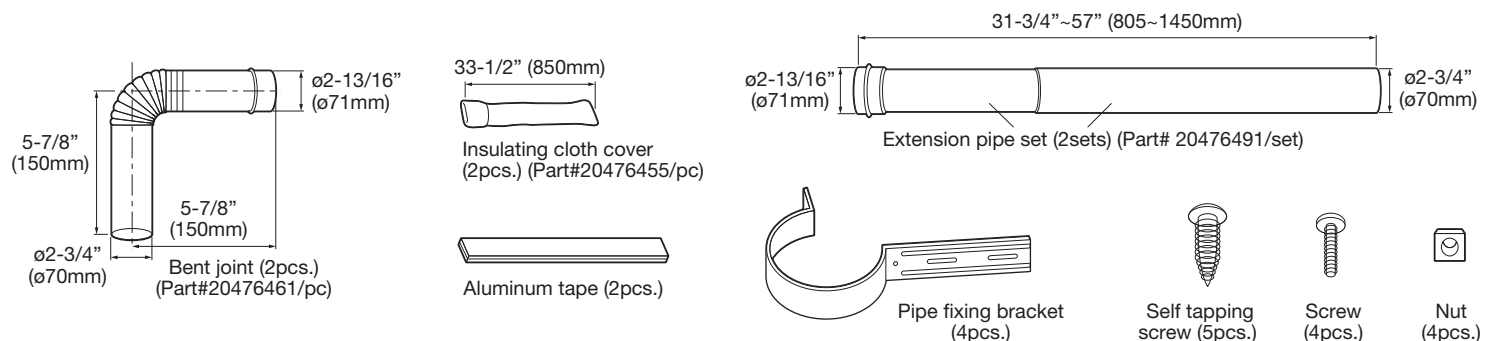

CAUTION: Total length of the extension pipe between the water heater and the flue pipe must be no greater than 10ft. with a total of three bends.

NOTE: When using exhaust pipes always cover the exhaust pipe with the insulating cloth cover.

Extension Flue Pipe
#20476486

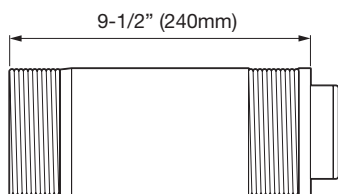

NOTE: This extension fluepipe is for wall thick-ness from 10-5/8 in. (270mm) to 18-1/8in. (460mm).

Lead Wire for Circulation Pump (4.9ft) (Black w/couplers)
#20476996

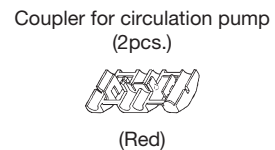
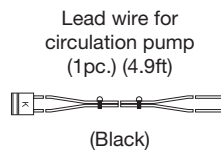

Lead Wire for Timer (4.9ft) (Yellow w/couplers)
#20476997

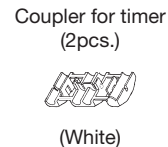
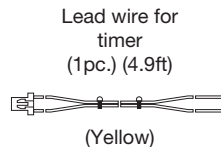

Jumper Terminal Set
#20476488

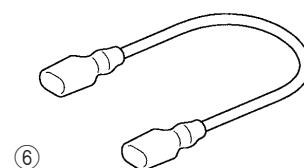
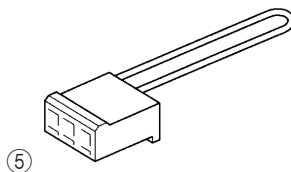
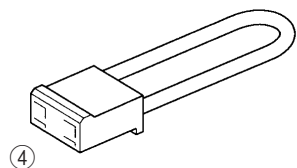
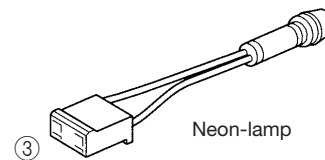
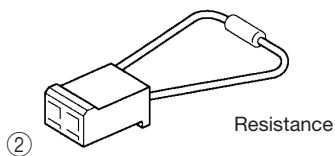
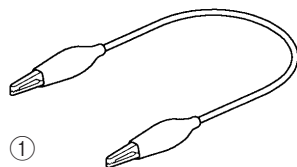

Fuel Pump Pressure Gauge Assembly
#10005089

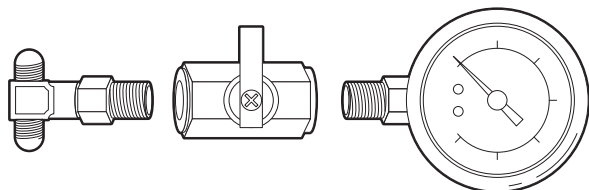

Electrode Gap Gauge
#10005027

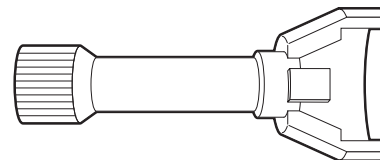

TOYOTOMI U.S.A., INC.

604, Federal Road, Brookfield, CT 06804
(203)775-1909

DISTRIBUTOR / DEALER NAME